

Clear PVC Piping System

1. System Description

Hershey Clear PVC pipe and fittings are corrosion resistant, easy to install and have transparency.

They are designed for **double containment application**, providing protection for human and equipment from damages. Hershey Clear pipe are generally used as **protection layer** – not commonly used for pressure pipe filled with fluids.

Hershey Clear PVC pipe and fittings are recommended to be stored at ambient temperature, without direct sunlight exposure. Attention should be paid during transportation where the pipe should be properly covered to avoid warping of pipe due to over exposure to sunlight.

Hershey offers Clear PVC pipe from 1/2” to 12” with plain end easy connection. Hershey Clear PVC pipe ranging from 1/2” to 4” are compliant with SCH 40 dimensions while 6” to 12” meets Hershey’s own company standards.

Standard supply length is 3 meter while other lengths can be made upon request.

Smaller diameter Clear PVC fittings from 1/2” to 4” are injection molded to SCH 40 or SCH 80 dimensions. Larger diameter fittings from 6” to 12” can be fabricated from standard Clear PVC pipes or simply replace with non transparent PVC fittings.

1.1 Product Advantages

- Excellent transparency
- Leakage monitoring
- Chemical resistance
- Lightweight, easy to handle
- Ease to install, joined by solvent cement
- Low friction loss
- Corrosion resistant
- Non-conductive
- Immune to microbiologically influenced corrosion

1.2 Basic Physical Properties

Physical Properties	Metric units	Imperial units	Test Condition	Standard
Specific Gravity	1.35		23°C	ASTM D792
Softening Temp (Vicat)	67°C	153°F	Loading 50N	ASTM D1525
Heat Deflection Temp.	63°C	145°F	264psi, Annealed	ASTM D790
Modulus of Elasticity in Tension	2,830N/mm ²	425,000psi	23°C,5mm/min	ASTM D638
Tensile Strength	54.3N/mm ²	7880psi	23°C,5mm/min	ASTM D638
Elongation	92%		23°C, 5mm/min	ASTM D638
Izod Impact (Notched)	31J/m	0.59ft-lb/in	10mm/0.5kg	ASTM D256
Max Service Temp.	50°C	122°F	-	-
Flammability	V0			UL-94

Note : Data shown above are typical values.

1.3 Reference Standards

- ASTM D256 Standard Test Methods for Determining the Izod Pendulum Impact Resistance of Plastics
- ASTM D638 Standard Test Method for Tensile Properties of Plastics
- ASTM D1525 Standard Test Method for Vicat Softening Temperature of Plastics
- ASTM D1784 Standard Specification for Rigid Poly (Vinyl Chloride) (PVC) Compounds and Chlorinated Poly (Vinyl Chloride) (CPVC) Compounds and Chlorinated Poly (Vinyl Chloride) (CPVC) Compounds
- UL 94 Tests for Flammability of Plastic Material for Parts in Devices and Appliance

2. Engineer Information

2.1 Clear PVC Pipe Pressure Rating - PVC 2110

Size	Max. Working Pressure	
	Kgf/cm ²	psi
1/2”	21.2	300
3/4”	16.9	240
1”	15.5	220
1-1/4”	12.7	180
1-1/2”	12	170
2”	9.9	140
2-1/2”	10.6	150
3”	9.2	130
4”	7.7	110
6”	6.3	90
8”	5.6	80
10”	4.9	70
12”	4.5	65

2.2 Temperature Derating Factors – Clear PVC Pipe

Working Temperature		Derating factor
°F	°C	
73	23	1.00
80	27	0.88
90	32	0.75
100	38	0.62
110	43	0.51
120	49	0.40

3. Product Dimension and Drawing

3.1 SCH 40 Clear PVC Pipe

Size	Standard			
	D	Tolerance	t(min)	Tolerance
1/2”	21.34	±0.10	2.77	+0.51
3/4”	26.67	±0.10	2.87	+0.51
1”	33.40	±0.13	3.38	+0.51
1-1/4”	42.16	±0.13	3.56	+0.51
1-1/2”	48.26	±0.15	3.68	+0.51
2”	60.32	±0.15	3.91	+0.51
2-1/2”	73.02	±0.18	5.16	+0.61
3”	88.90	±0.20	5.49	+0.66
4”	114.30	±0.23	6.02	+0.71
* 6”	168.28	±0.28	7.00	+1.00
* 8”	219.08	±0.38	7.00	+1.00
* 10”	273.05	±0.38	8.00	+1.50
* 12”	323.85	±0.38	8.00	+1.50

Note : Do not comply with ASTM standards, if mark with *. (unit : mm)

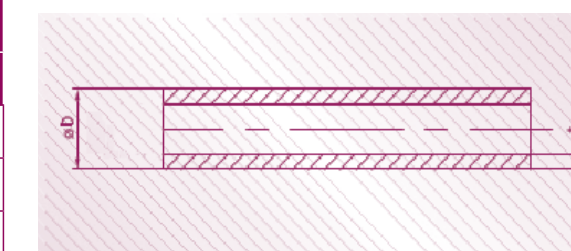

3.2 SCH 80 Clear PVC 90° Elbow (Slip×Slip)

Size	Outside Dia	Socket Type			Structure Diameter	
	D0	d1	d2	l	d	G
1/2”	31.5	21.54	21.23	22.22	16.5	12.8
3/4”	38	26.87	26.57	25.4	22	15.3
1”	46	33.65	33.27	28.58	28	18
1-1/4”	55	42.42	42.04	31.75	35	23
1-1/2”	60	48.56	48.11	34.93	43	26
2”	75	60.63	60.17	38.1	54	32
2-1/2”	90	73.38	72.85	44.45	69	38
3”	107	89.31	88.70	47.63	84	48
4”	133	114.76	114.1	57.15	105	59

(unit : mm)

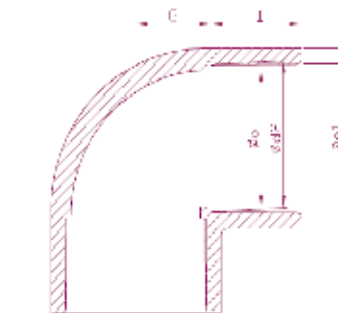

3.3 SCH 80 Clear PVC 45° Elbow (Slip×Slip)

Size	Outside Dia	Socket Type			Structure Diameter	
	D0	d1	d2	l	d	J
1/2”	30.5	21.54	21.23	22.22	16.5	6.5
3/4”	40	26.87	26.57	25.4	22	8
1”	46	33.65	33.27	28.58	28	8
1-1/4”	56	42.42	42.04	31.75	35	10
1-1/2”	62.5	48.56	48.11	34.93	43	12
2”	75.5	60.63	60.17	38.1	54	16
2-1/2”	90	73.38	72.85	44.45	69	18
3”	107	89.31	88.70	47.63	84	20
4”	133	114.76	114.1	57.15	108	26

(unit : mm)

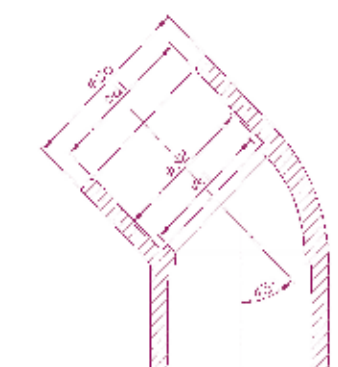

3.4 SCH 80 Clear PVC Coupling (Slip×Slip)

Size	Outside Dia	Socket Type			Structure Diameter	
	D0	d1	d2	l	d	L
1/2”	30.5	21.54	21.23	22.22	16.5	50
3/4”	38	26.87	26.57	25.4	22	63.5
1”	46	33.65	33.27	28.58	28	70
1-1/4”	55.5	42.42	42.04	31.75	35	75
1-1/2”	61	48.56	48.11	34.93	42.5	77
2”	73.5	60.63	60.17	38.1	54	84
2-1/2”	89	73.38	72.85	44.45	65	100
3”	106	89.31	88.70	47.63	80	108
4”	133	114.76	114.1	57.15	100	126

(unit : mm)

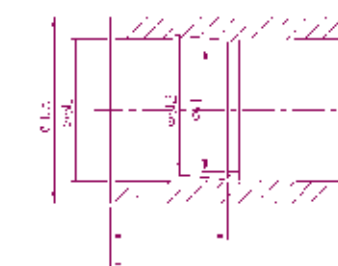



CPVC Advanced Industrial Piping System
CPVC工業管路系統



Thermoplastic Valves
塑膠閥門(凡而)



UPVC Industrial Piping System
UPVC工業管路系統



CPVC High Performance Fire Sprinkler System
CPVC高效能消防管路系統



PVC-MI Cable Tray
防火耐燃電纜線槽

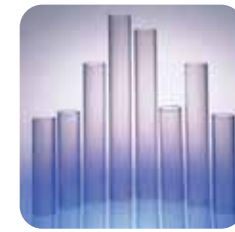

Clear PVC Piping System
PVC透明管路系統



CPVC/HT-PVC Sheet
CPVC / HT-PVC板材



CPVC Hot & Cold water Distribution System
CPVC熱水管道系統

3.5 SCH 80 Clear PVC Tee (Slip×Slip×Slip)

Size	Outside Dia		Socket Type			Structure Diameter		
	D0	d1	d2	l	d	L	H	
1/2"	30	21.54	21.23	22.22	16.5	73	37.25	
3/4"	37	26.87	26.57	25.4	24	89.5	42.5	
1"	46	33.65	33.27	28.58	28	103	51.5	
1-1/4"	55.5	42.42	42.04	31.75	35	119.5	57.75	
1-1/2"	63.5	48.56	48.11	34.93	41	128	64	
2"	75	60.63	60.17	38.1	52	152	73	
2-1/2"	92	73.38	72.85	44.45	69	173	86.5	
3"	109	89.31	88.70	47.63	84	197	98.5	
4"	135	114.76	114.1	50.8	109	239	119.5	

(unit : mm)

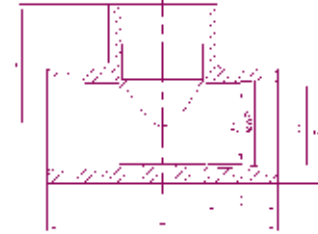

3.8 SCH 40 Clear PVC Coupling (Slip×Slip)

Size	Outside Dia		Socket Type			Structure Diameter	
	D0	d1	d2	l	d	L	
1/2"	27.5	21.54	21.23	17.8	18	38.6	
3/4"	33.5	26.87	26.57	22.1	22.5	47.5	
1"	41.7	33.65	33.27	26.6	29	50.7	
1-1/4"	50.5	42.42	42.04	27.7	38	58.1	
1-1/2"	56.8	48.56	48.11	28.3	43.5	60	
2"	69	60.63	60.17	29.9	55.5	63.5	
2-1/2"	84.2	73.38	72.85	45	67.5	95	
3"	100.8	89.31	88.70	48.1	83.5	101.2	
4"	127.3	114.76	114.07	51.3	108.5	107.6	

(unit : mm)

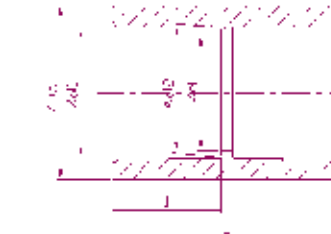

3.6 SCH 40 Clear PVC 90° Elbow (Slip×Slip)

Size	Outside Dia		Socket Type			Structure Diameter	
	D0	d1	d2	l	d	G	
1/2"	27.5	21.54	21.23	17.8	18	12.7	
3/4"	33.6	26.87	26.57	22.2	22.5	14.8	
1"	41.7	33.65	33.27	26.1	29	18.3	
1-1/4"	50.5	42.42	42.04	27.7	38	22.7	
1-1/2"	56.8	48.56	48.11	28.3	43.5	25.7	
2"	69	60.63	60.17	29.9	55	32	
2-1/2"	84.2	73.38	72.85	45	67.5	39	
3"	100.8	89.31	88.70	48.1	83.5	46.5	
4"	127.3	114.76	114.07	51.3	108.5	59.7	

(unit : mm)

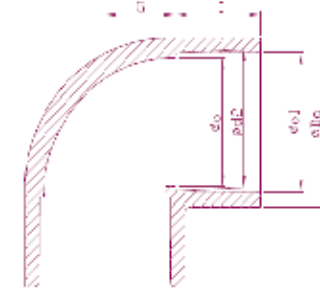

3.9 SCH 40 - Tee (Slip×Slip×Slip)

Size	Outside Dia		Socket Type			Structure Diameter		
	D0	d1	d2	l	d	L	H	
1/2"	27.5	21.54	21.23	17.8	18	61	30.5	
3/4"	33.6	26.87	26.57	18.7	22.5	67	33.5	
1"	41.7	33.65	33.27	22.7	29	82	41	
1-1/4"	50.5	42.42	42.04	24.3	38	94	47	
1-1/2"	56.8	48.56	48.11	28.3	43.5	108	54	
2"	69	60.63	60.17	29.9	55	124	62	
2-1/2"	84.2	73.38	72.85	45	67.5	168	84	
3"	100.8	89.31	88.70	48.1	83.5	189.2	94.6	
4"	127.3	114.76	114.07	51.3	108.5	222	111	

(unit : mm)

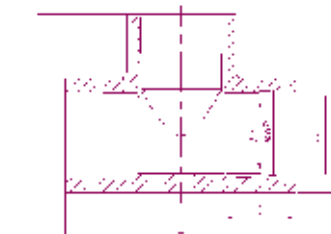

3.7 SCH 40 Clear PVC 45° Elbow (Slip×Slip)

Size	Outside Dia		Socket Type			Structure Diameter	
	D0	d1	d2	l	d	L	
1/2"	27.5	21.54	21.23	17.8	18	6.4	
3/4"	33.1	26.87	26.57	18.7	22.5	8	
1"	40.9	33.65	33.27	22.7	29	8	
1-1/4"	50.1	42.42	42.04	24.3	38	9.6	
1-1/2"	56.5	48.56	48.11	28.3	43.5	11.2	
2"	69	60.63	60.17	29.9	55	16	
2-1/2"	84.2	73.38	72.85	45	67.5	18	
3"	100.8	89.31	88.70	48.1	83.5	20	
4"	127.3	114.76	114.07	51.3	108.5	25.4	

(unit : mm)



環琪塑膠股份有限公司
Hershey Valve Co., Ltd.

43541 台中市梧棲區中港加工出口區經二路16號
No.16, Jing 2nd Rd., Wuchi, Taichung,
ChungKang Export Processing Zone, 43541 Taiwan, R.O.C.
Tel : +886-4-2659 5377 Fax : +886-4-2659 5288
Http : //www.hershey.com.tw
E-mail : info@hershey.com.tw



Clear PVC Piping System

Product Information